

Kenngroßen	Typ	KLUB-434	KLUB-41
port size		G 3/4	G 1
description		lubricator with automatic oil filling	
medium		compressed air, neutral gases	
mounting		vertical	
medium- and ambient temperature		max. 50 °C	
supply pressure		Pe max. 16 bar	
bowl volume		oil quantity max.	
oil metering qv=1000l/min		1 - 2 drops/min	
oil type		CL 32 DIN 51517 - ISO VG 32	
fixing		mounting bracket, wall mounting	
weight		0,762 kg	

Innovation
2009!



material: Grivory (PA66) / IXEF1022

Technical modifications keep on reserve!

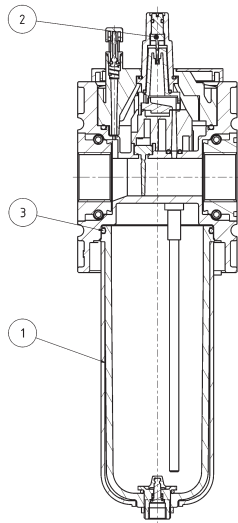

parts

no.	designation		material	order-no.
1	bowl	BE.4 LUB	polycarbonate	90004.0202
2	dome assembly	ESA-1-1312	polycarbonate	99901.1312
3	o-ring 55 x 2,5	OR.0-9	NBR	10020.0009

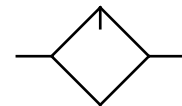

series 4

ordering information

KLUB - *** *

type

1 port size

2 accessories

ordering example: KLUB-434

1	port size	
	434	G 3/4
	41	G 1
	434 NPT	3/4-14 NPT
	41 NPT	1 - 11 1/2 NPT
2	accessories (see reverse side)	
	H	metal bowl with level indicator
	N	electrical level indicator

page: KLUB-4 (01/09)

application information

- Can be filled with oil during operation
- Interlocking of several individual devices requires coupling kit(s) KKOP.4

dimensions (mm)

Can be filled with oil during operation

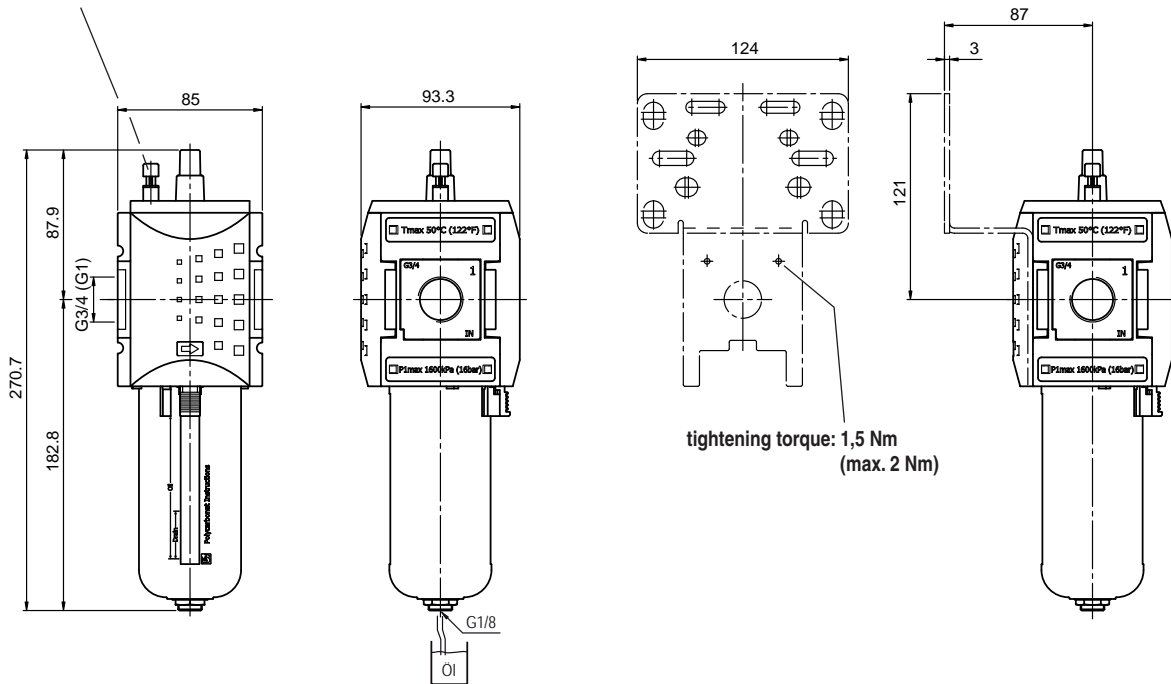

pressure characteristic

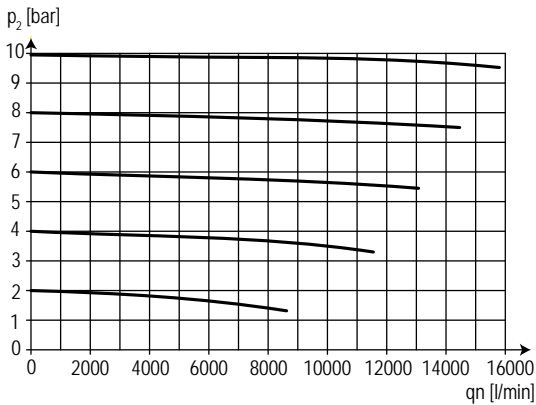

lubricator operating limit

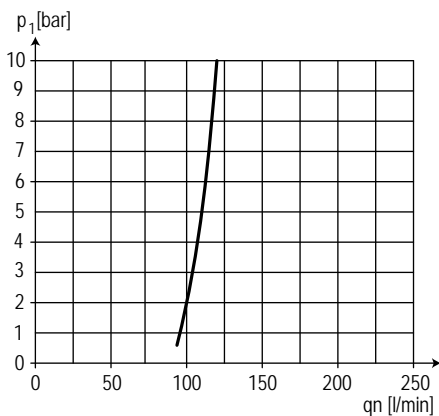

accessories 2

mounting bracket with screws

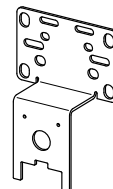

type: KBW.4-1225

metal bowl with level indicator

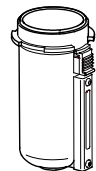

type: BE.4 H LUB

coupling kit

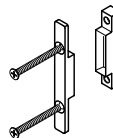

type: KKOP.4

coupling kit wall mounting

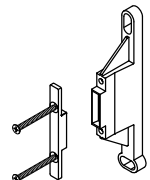

type: KKOP.4W